

BANG & OLUFSEN

BEOSYSTEM 4500

CAUTION: Use of any controls, adjustments or procedures other than those specified herein may result in hazardous radiation exposure.

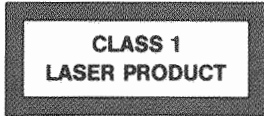

The black and yellow label on the compact disc player serves as a warning that the apparatus contains a laser system and is classified as a class 1 laser product. In case of any trouble with the compact disc player, please contact your Bang & Olufsen dealer. The apparatus must be opened by qualified servicemen only.

© Bang & Olufsen 1988

Printed in Denmark by Bogtrykergården a-s, Struer

Beosystem 4500

The Beosystem 4500 consists of:

- the Beomaster 4500, an AM/FM tuner/amplifier with 20 presets. It is a stereo radio which automatically reproduces stereo sound if tuned to an FM station transmitting in stereo.
- the Beocord 4500, a tape recorder equipped with the HX Pro system, developed by Bang & Olufsen, to ensure optimum recording quality.
- the Beogram CD 4500, a compact disc player with outstanding sound reproduction quality. It is equipped with a special disc clamber allowing it to be hung vertically on a wall.
- the Beogram 4500, a record player equipped with a RIAA pre-amplifier, meaning that if it is to be connected to a tuner/amplifier other than the Beomaster 4500, it must be connected to a Tape or Aux socket, that is a socket intended for a LINE signal.

 HX - PRO

COMPACT
disc
DIGITAL AUDIO

Operating the Beosystem 4500 is extremely simple and logical. The controls on the sloping sensi-touch panel give you access to all the functions. All you have to do is touch the appropriate text or symbol.

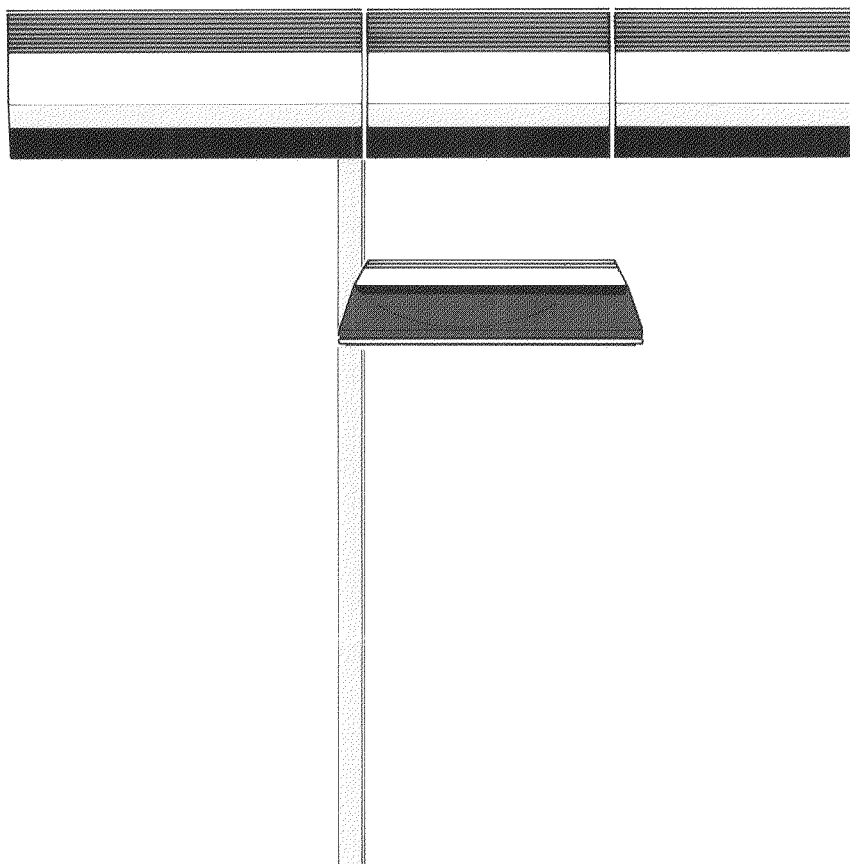

Beolink

The Beomaster 4500 is a Beolink product, which means that it can be used as a master in a Bang & Olufsen Beolink system. In a Beolink system audio and video products are interconnected, and they can be operated using only one remote control unit - the Beolink 1000.

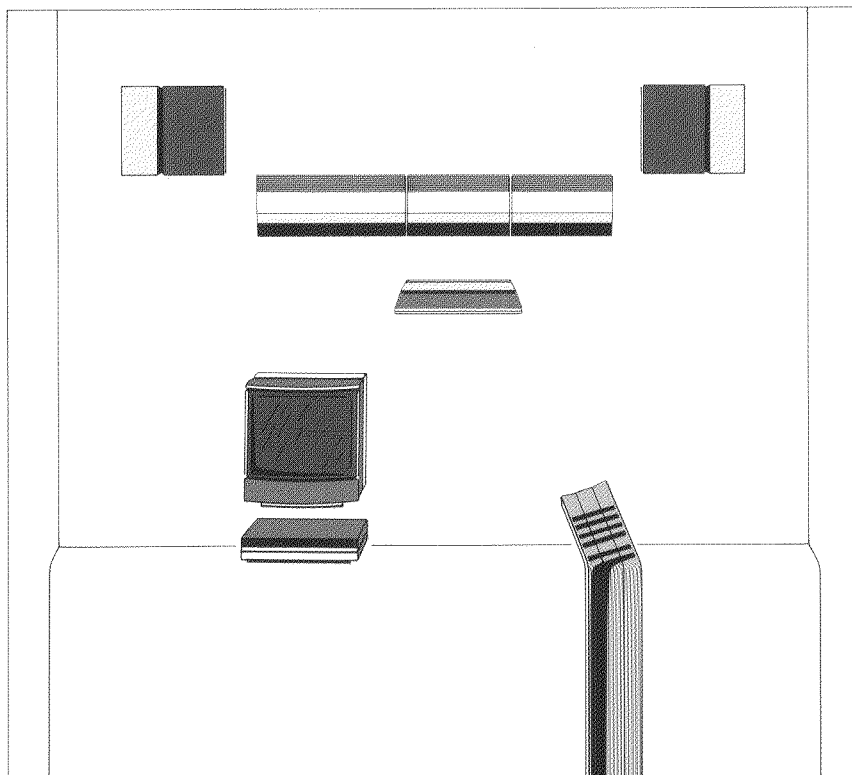

How to use this manual

This manual explains how to set up and operate each unit of the Beosystem 4500.

The lay-out of the manual ensures that you can easily find your way through it. The section »Setting up« explains how to make the units of the Beosystem 4500 ready for use. For operation of the Beomaster 4500, the Beocord 4500, the Beogram CD 4500 and the Beogram 4500, see the appropriate section. If you look for a specific function, the detailed table of contents will serve as your guide.

The instructions in the manual refer to the sensi-touch fields of the appropriate unit and are indicated by small boxes with the appropriate text or symbol inside them.

TABLE OF CONTENTS

6 SETTING UP

- Making the Beograms ready for play
- Where to place the Beosystem 4500
- Connections
- Stand-by mode

10 THE BEOMASTER 4500

- The operation panel
- Switching on
- Switching off
- Muting
- Automatic stand-by
- Tuning and presetting radio stations
 - Automatic tuning / Tuning by keying in the frequency / Manual tuning
- FM and AM frequency ranges
- Sound adjustments
 - Volume / Balance / Bass / Treble / Loudness
- Sockets on the rear panel

20 THE BEOCORD 4500

- Loading a cassette
- Playing back a tape
- Winding and rewinding
- Stepping through tracks
- Recording
- Using the auto reverse function
- Using Dolby NR*
- Recording level

24 THE BEOGRAM CD 4500

- Loading a compact disc
- Playing a compact disc
- Searching through a compact disc
- Stepping through tracks
- Digital output

26 THE BEOGRAM 4500

- Adjusting stylus pressure
- Setting speed
- Playing a record
- Pausing
- Stepping through a record
- Repeating a record

30 REMOTE CONTROL

Primary functions

32 THE BEOMASTER 4500 IN A BEOLINK SYSTEM

○ Pre-programming ○ How to obtain the Beolink functions

35 OPTIONAL ACCESSORIES

○ WB 4500 wall bracket ○ Cable Cover 4500 ○ Headphones
○ Indoor antennae ○ Beolink cable
○ Master Control Link 2

38 MAINTENANCE

○ Surfaces ○ Tape path ○ Stylus

40 TECHNICAL SPECIFICATIONS

42 INTERNATIONAL GUARANTEE

*Trademark of Dolby Laboratories Licensing Corporation.
Noise reduction system manufactured under License from Dolby Laboratories Licensing Corporation.

SETTING UP

Making the Beograms ready for play

Beogram CD 4500

If the CD-player has been exposed to low temperatures during transport and is then placed in a warm room, condensation can form within the mechanism. If this happens, the CD-player cannot function until the humidity drops to an acceptable level. Therefore, allow it to adjust to room temperature for at least an hour or two before use.

Beogram 4500

The record player is provided with screws on the base to protect the suspension during transport. These screws must be loosened before you can operate the record player. Place the record player on a table so that the front protrudes over the edge. Hold the record player firmly and turn it carefully to locate and loosen each of the three screws. Turn the screws anti-clockwise (several turns) using a screwdriver or a coin. The screws cannot be removed from the holes.

The CD-player is provided with screws on the base to protect the suspension during transport. These screws must be removed before you can operate the CD-player. Tilt the CD-player to an upright position while holding it firmly. Remove the two red screws and place them in the storage holes.

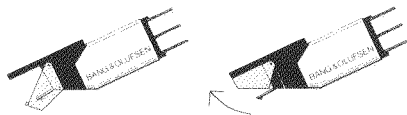

Remove the foam rubber pieces protecting the tonearm. Be careful not to catch the stylus. Place the platter on the turntable and check that it can move freely. It should feel springy when pressed lightly. Don't forget to raise the stylus guard on the cartridge.

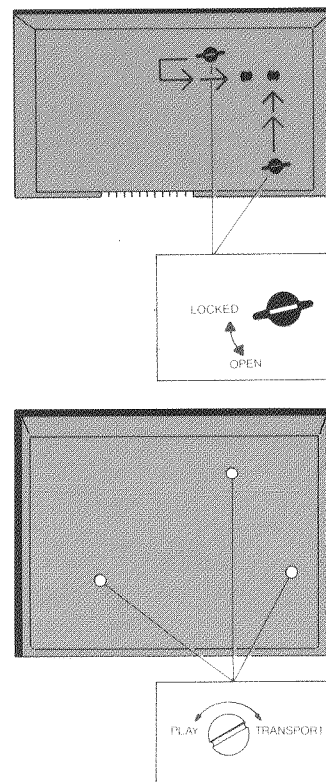

If you ever have to transport the Beograms, we strongly recommend you tighten the transport screws before you do so.

Where to place the Beosystem 4500

All the units of the Beosystem 4500 must be placed so that ventilation is not impeded. Avoid placing them in direct sunlight, near radiators or other sources of heat.

Leave a space of at least 15 cm above the tape recorder and CD-player and at least 25 cm above the record player to allow the dust covers to open freely.

The plastic feet supplied with the Beomaster 4500, the Beocord 4500 and the Beogram CD 4500 enable you to place the products in a slightly tilted position on a stable surface. Insert the feet in the holes provided on the base. The Beogram 4500, however, must be placed horizontally.

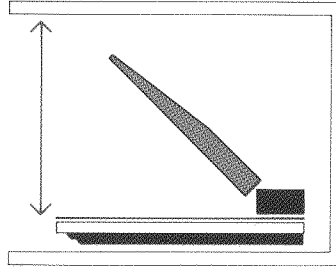

Alternatively, the Beosystem 4500 can be hung on a wall. The WB 4500 wall bracket is available as an optional accessory for this purpose; please see "Optional accessories".

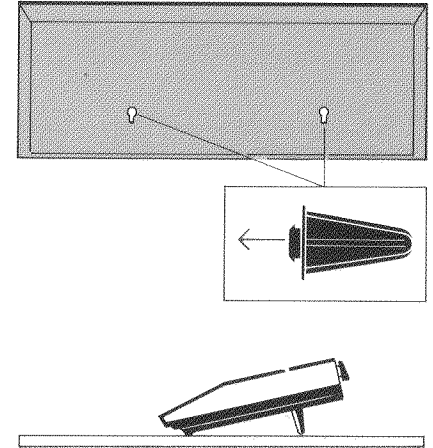

The metal bars supplied with the Beomaster 4500, the Beocord 4500 and the Beogram CD 4500 are for concealing cables. When you have made the necessary connections, insert the bars in the holes provided on the rear panels and press downwards.

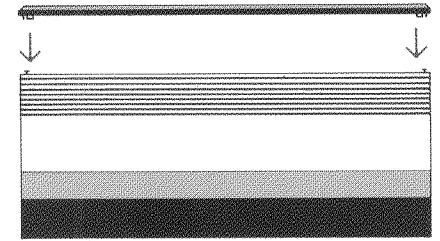

Connections

The diagram shows which sockets to use when connecting the Beo-system 4500. Connect loudspeakers, antennae and the other units to the Beomaster before connecting it to the mains supply. For a detailed explanation of all the sockets on the rear panel of the Beomaster 4500, please see "Sockets on the rear panel".

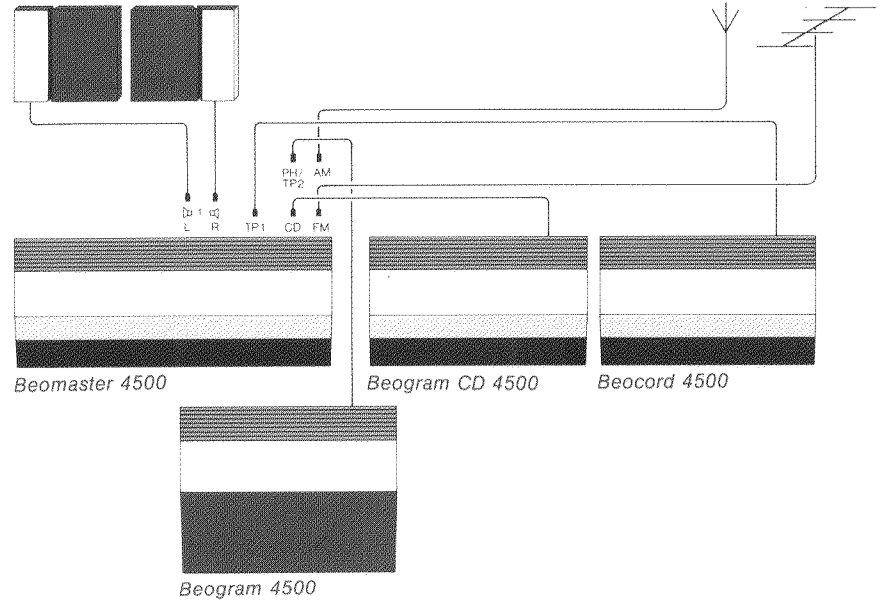

Stand-by mode

Once connected to the mains, each unit in the Beosystem 4500 is in stand-by mode and ready to be operated. Stand-by mode is indicated by a tiny red light on the right-hand side of the operation panel. The Beosystem 4500 is designed to be left in stand-by mode when not in use.

THE BEOMASTER 4500

This section explains how to operate the Beomaster 4500. Before you start using the tuner/amplifier, make sure you have made all the

necessary connections. For details about making your Beomaster 4500 ready for use, please refer to the section "Setting up".

The operation panel



The controls identified by grey print on the operation panel give you access to the primary functions. You will find that other controls appear in green colour when you have pressed some of the primary controls. They will light up for a limited period of time, so if they disappear before you have finished your instructions, you simply start again.

When you operate the Beomaster, cues in red colour appear above the primary controls. They indicate music source, sound adjustments and whether you are on the FM or AM band.

A 4-digit display, also located in the upper part of the operation panel, will give you information on preset numbers, frequencies, sound levels and options.

Switching on

Switch on by selecting any of the music sources available in your Beosystem 4500. Touch the appropriate text:

CD Turns on the Beogram CD 4500 compact disc player.
If you press **PLAY** on the Beogram CD 4500 to start playing a compact disc, the Beomaster switches on automatically.

PHONO Turns on the Beogram 4500 record player.
If you press **PLAY** on the Beogram 4500 to start playing a record, the Beomaster switches on automatically.

TAPE 2 Turns on any second Bang & Olufsen tape recorder equipped with Datalink.

TAPE 1 Turns on the Beocord 4500 tape recorder.
If you press **PLAY** on the Beocord 4500 to start playback, the Beomaster switches on automatically.

AUX Selects the AUX/TV socket as the source. For further details, see "Sockets on the rear panel".

0 - 9 Turns on the radio station preset on the appropriate number (max. 20).

0 Turns on the radio station you were last listening to.

MUTE Turns on the source in your Beosystem 4500 you were last listening to.

Whenever you switch on, the source selected will start playing at the preset sound level stored in the Beomaster. The source selected will be indicated on the operation panel of the Beomaster 4500.

Switching off

Switch off by pressing  on the right-hand side of the operation panel. The Beomaster will revert to

stand-by mode. The other units in the Beosystem 4500, if any, will also revert to stand-by mode.

Muting

Press **MUTE** to make the sound disappear immediately. This is useful if you want temporary silence without switching off. Press **MUTE** again to recall the sound.

The mute function only applies to the loudspeakers connected to the upper pair of speaker sockets.

Automatic stand-by

Within 30 minutes of finishing a record, a tape or a compact disc, the Beosystem 4500 automatically returns to stand-by.

Tuning and presetting radio stations

The radio must be tuned to pick up the stations available in your area. You can preset a total of 20 stations.

Automatic tuning

The automatic tuning function is useful if you are not familiar with the radio stations and their frequencies.

The tuning of radio stations can be carried out in three different ways.

1. Switch on by pressing any of the numbers **[0]** - **[9]**.
The chosen number is displayed.
2. Press **[PROGRAMMING]**.
The display indicates the current frequency, and the controls **GO TO** and **STORE** become accessible.
3. Press **[GO TO]**.
The display indicates ----, and the controls **AM/FM**, **<** and **>** become accessible.
4. Press **[AM/FM]** if you want to switch from AM to FM or vice versa.
5. Press **[>]** to search upwards or **[<]** to search downwards through the frequencies.
The Beomaster will stop at the first station producing an acceptable signal.
If this is not the station you want, press **[>]** or **[<]** again.
6. Press **[STORE]** to preset the station found.
The first vacant preset number flashes.
7. If you do not want to use this number, key in the number of your choice.
8. Press **[STORE]** another time to preset the station.

Tuning by keying in the frequency



If you know the exact frequency of the station you want, you can key it in directly:

1. Switch on by pressing any of the numbers **[0]** - **[9]**.
The chosen number is displayed.
 2. Press **[PROGRAMMING]**.
The display indicates the current frequency, and the controls **GO TO** and **STORE** become accessible.
 3. Press **[GO TO]**.
The display indicates ----, and the controls **AM/FM**, **<** and **>** become accessible.
 4. Press **[AM/FM]** if you want to switch from AM to FM or vice versa.
 5. Key in the appropriate frequency using three or four digits, as required.
 6. Press **[STORE]** to preset the station found.
The first vacant preset number flashes.
 7. If you do not want to use this number, key in the number of your choice.
 8. Press **[STORE]** another time to preset the station.
-

Manual tuning

The manual tuning function is useful if you want to search slowly through the frequencies, or if you want to detune a station slightly due to noisy reception.

1. Switch on by pressing any of the numbers **[0]** - **[9]**.
The chosen number is displayed.
2. Press **[PROGRAMMING]**.
The display indicates the current frequency, and the controls **GO TO** and **STORE** become accessible.
3. Press **[GO TO]**.
The display indicates ----, and the controls **AM/FM**, **<** and **>** become accessible.
4. Press **[AM/FM]** if you want to switch from AM to FM or vice versa.
5. Press **[GO TO]** another time.
The display indicates the current frequency, and the controls **AM/FM** and **STORE** disappear.
6. Keep your finger on **[>]** to search slowly upwards or on **[<]** to search slowly downwards through the frequencies until you have found the station you want.

The longer you keep your finger on  or , the higher the search speed.

7. Press  to preset the station found.

The first vacant preset number flashes.

8. If you do not want to use this number, key in the number of your choice.

9. Press  another time to preset the station.

Repeat any of these procedures to tune in and preset other stations.

If you tune in a frequency (station) which you have already preset, this preset number will appear

in the display rather than the first vacant preset number. This serves as a reminder that you have already preset the station.

If you switch on by selecting a

preset number to which a station has not been assigned, the tuner will move to the start of the FM band (87.5 MHz).

FM and AM frequency ranges

The frequencies in the FM band range from 87.5 MHz to 108.0 MHz.

The frequencies in the AM band range from 150 kHz to 1610 kHz.

The AM band covers both LW and MW stations:



- LW stations are between 150 and 350 kHz
- MW stations are between 520 and 1610 kHz

The  control is used to switch between the FM and AM bands. Each time you switch from the FM band to the AM band or vice versa, the tuner will move to the start of the band.

The display indicates AM frequencies in kHz with no decimals. FM frequencies are stated in MHz with one decimal.



Sound adjustments

Volume

Press  to raise the volume level.
Press  to lower the volume level.

When you adjust the volume, the current volume level will be indicated by a figure in the display: 00 as the lowest and 90 as the highest.

Whenever you switch on, the Beomaster 4500 will start playing at a preset volume level. You can set this start-up volume level to suit your personal taste.

1. Press **[SOUND]** once.
2. Adjust the volume to the desired level using  or .
3. Press **[STORE]** to memorize the new level.





Note!

The Beomaster will not start playing at a volume level exceeding 70. If you have preset a start-up level

higher than that, it will disregard your instructions and start playing at 70 instead.

Balance



Balance is an indication of the distribution of sound emerging from the two loudspeakers. You may wish to alter the balance to suit your favourite listening position. The balance setting ranges from 0 to 7 for either speaker. The middle setting is indicated by ---- in the display.

1. Press **[SOUND]** twice.
2. Adjust the balance using  or  while the BAL cue is visible. Pressing  shifts sound to the right loudspeaker, and pressing  shifts sound to the left loudspeaker.

3. Press **[STORE]** if you want to memorize the new balance.

Bass



The bass level can be adjusted to suit your personal taste. The bass setting ranges from +6 to -6. The medium setting is indicated by -- in the display.

1. Press **[SOUND]** three times.
2. Adjust the bass to the desired level using  or  while the BASS cue is visible.

3. Press **[STORE]** if you want to memorize the new level.
-

Treble



The treble level can be adjusted to suit your personal taste. The treble setting ranges from +6 to -6. The medium setting is indicated by -- in the display.

1. Press **[SOUND]** four times.
2. Adjust the treble to the desired level using  or  while the TREBLE cue is visible.

3. Press **[STORE]** if you want to memorize the new level.
-

Loudness

The loudness function is used to compensate for the human ear's lack of sensitivity to high and low frequencies when you are listening at low volume levels. It 'boosts' the high and low frequencies so that the music becomes more dynamic. You can cut the loudness function in or out as you please.

1. Press **[SOUND]** five times to get access to the loudness function. The LOUDN cue flashes if the function is cut out, and it glows constantly if it is cut in.
2. Press  to cut in the loudness function, or press  to cut it out.

3. Press **[STORE]** if you want to memorize the new setting.
-

Adjusting and presetting volume, balance, bass, treble and loudness may be done in one step by pressing **[SOUND]** only once between

each adjustment, and by pressing **[STORE]** only after the last adjustment.

Sockets on the rear panel

AM

Socket for connection of an AM antenna.

FM

Socket for connection of an FM antenna.

CD

7-pin DIN socket for connection of the Beogram CD 4500 compact disc player or any other Bang & Olufsen compact disc player.

TP1

7-pin DIN socket for connection of the Beocord 4500 tape recorder or any other Bang & Olufsen tape recorder.

AUX/TV

7-pin DIN socket for connection of a Beolink compatible TV-set or for connection of auxiliary equipment without Datalink.

PH/TP2

7-pin DIN socket for connection of the Beogram 4500 record player, a second tape recorder or CD-player.

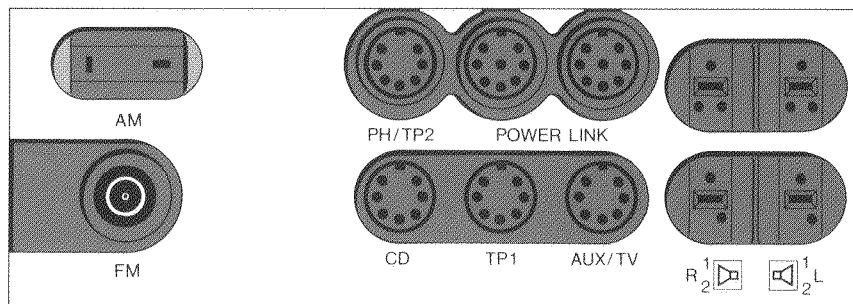

POWER LINK

8-pin DIN sockets for connection of Bang & Olufsen loudspeakers with Power Link plugs. The Power Link sockets are identical, which means that either socket may be used for the left or right loudspeaker. You can also connect just one loudspeaker to a Power Link socket, and then loop the signal to the other loudspeaker using a Power Link cable.

1 L/R

4-pin DIN sockets for connection of one set of loudspeakers. L for left channel and R for right channel.

The Beomaster is designed for loudspeakers with an impedance of no less than 8 ohms.

2 L/R

3-pin DIN sockets for connection of another set of loudspeakers or a Master Control Link 2 system. L for left channel and R for right channel.

Note!

The sockets PH/TP2 and AUX/TV can be set to accommodate different types of equipment. If for example you want to connect a second tape recorder to the AUX/TV socket, you simply change the option of the Beomaster. The Beomaster 4500 must be in stand-by mode while you are doing so.

When the Beomaster 4500 leaves the factory, it is set to the TAPE 2 option. The previous description of connection possibilities applies to this option. When set to the CD or PHONO option, the connection possibilities are:

1. Press **PROGRAMMING** and **7** simultaneously to reveal the current option.
The display indicates OP, and the appropriate cue TAPE 2, CD or PHONO lights up.

2. Press **TAPE 2**, **CD** or **PHONO**, as the case may be, to select the option of your choice.

<u>Socket:</u>	<u>Option CD:</u>	<u>Option PHONO:</u>
<u>PH/TP2</u>	Connection of the Beogram 4500 record player.	Connection of a record player without a built-in RIAA pre-amplifier. In this case, the Beomaster 4500 must be fitted with a RIAA pre-amplifier (part no. 8002956). Contact your Bang & Olufsen dealer.
<u>AUX/TV</u>	Connection of a Beolink compatible TV-set or a Bang & Olufsen tape recorder.	Connection of a Beolink compatible TV-set or a Bang & Olufsen tape recorder.

THE BEOCORD 4500

This section explains how to operate the Beocord 4500. Before you start using the tape recorder, make

sure you have set it up according to the instructions in the section "Setting up".

Loading a cassette

The cassette compartment is under the hinged aluminium lid. To gain access to the cassette compartment, press **LOAD** on the operation panel. Place the cassette in the compartment with the tape slots facing you, and with side 1 (or A) pointing upwards.

Close the lid by pressing **LOAD** again. The lid may be left open during playback or recording. When the tape recorder is switched to stand-by, the lid closes automatically.

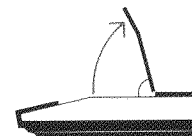

Playing back a tape

Press **PLAY** to start playback.

The tape recorder automatically adjusts to the type of tape used: metal, chrome or ferric.

If the tape was recorded with the Dolby B noise reduction system (please see "Using Dolby NR"), set the DOLBY NR switch to ON.

During playback the signal level of the recording is indicated by the lights in the horizontal scale (VU-meter) to the left.

If you have loaded a cassette which has not been rewound completely, you can start playback by pressing **START GO**. The tape will be rewound to the start of side 1, and playback will start immediately.

Playback continues until the tape runs out, or until you press **STOP** to stop playback. The tape will pause until you press **PLAY** again. You can also stop playback by pressing **●** to switch to stand-by.

Winding and rewinding

Press **>>** to wind the tape.

Press **<<** to rewind the tape.

Rewinding always means returning to the start of side 1, and winding always means moving to the end of side 2, unless you have cut out the automatic reverse function.

Stepping through tracks

Press **[STEP>]** once to step forwards to the next track. Press **[STEP>]** the number of times required to step to the desired track further ahead.

Press **<STEP]** to step backwards to the beginning of the track you are listening to. Press **<STEP]** twice or more to step to preceding tracks.

If you want to play a track two or more steps ahead or behind, keep your finger on **[STEP>]** or **<STEP]**. The **STEP>** or **<STEP]** cue flashes once for each step the tape recorder will make.

The tape recorder will only be able to recognize the tracks on a tape if there is a pause of at least 2.5 seconds between them.

Recording

If you want to use the Dolby B noise reduction system, set the DOLBY NR switch to ON.

1. Press **[REC]** once to switch to recording pause mode.
The cues REC and STOP light up.
2. Start playing the source you want to record from, e.g. the Beogram 4500*.
3. Adjust the recording level using the REC LEVEL slider.
4. Press **[REC]** a second time to start recording.
The STOP cue disappears leaving just the REC cue lit.

5. Press **[STOP]** once to stop recording.
The STOP cue lights up again, and the REC cue flashes briefly. The tape recorder will insert a blank of 4 seconds on the tape before stopping.
6. Press **[STOP]** again to leave the recording mode.

If you do not want the 4 second pause on your tape, press **[STOP]** twice in rapid succession.

* Subject to copyright law.

If you wish to change a recording which is already in progress, press **[<STEP]**. The tape will rewind to the spot where **[REC]** was last pressed, and you can now resume recording, or you can press **[STOP]** to leave the recording mode.

If you are recording from the Beogram CD 4500 or the Beogram 4500, recording stops automatically when the compact disc or record is finished. Likewise, if the tape runs out during recording, the Beogram CD 4500 or the Beogram 4500 stops automatically.

Using the auto reverse function

The Beocord 4500 features an automatic reverse function, which

means that you do not have to turn the tape manually. The tape record-

er automatically reverses the tape at the end of side 1 and continues playback or recording on side 2. The side of the cassette which is pointing upwards when loaded in the cassette compartment is regarded as side 1.

You can cut in or out the automatic reverse function as you please. Set the AUTO REV switch to ON to cut in the function, or set it to OFF to cut it out.



Using Dolby NR

The Dolby B noise reduction system can be switched on and off during playback or recording. Set the DOLBY NR switch to ON to cut in the function, or set it to OFF to cut it out.



Recording level

The REC LEVEL slider is used to adjust the signal level prior to recording. We recommend you keep the level around 0 dB with only occasional blinks in the red area on the VU-meter.

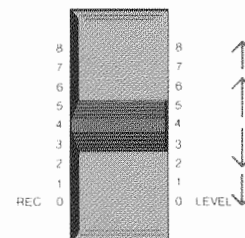

THE BEOGRAM CD 4500

This section explains how to operate the Beogram CD 4500. Before you start using the compact disc

player, make sure you have set it up according to the instructions in the section "Setting up".

Loading a compact disc

The disc compartment is under the hinged aluminium lid. To gain access to the disc compartment, press **[LOAD]** on the operation panel. Place the compact disc in the compartment with the printed side pointing upwards.

The lid closes automatically when playing is started. When the CD-player is switched to stand-by, the lid also closes automatically.

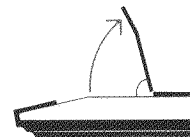

Playing a compact disc



Press **[PLAY]** to start playing a compact disc.

The CD-player registers all the tracks on the compact disc as indicated by the display on the operation panel. Track numbers above 14 are indicated by +.



As soon as all tracks are registered, playing starts at track 1.

Playing continues until the disc runs out, or until you press **[STOP]** to stop playing. The CD-player pauses until you press **[PLAY]** again. You can also stop playback by pressing **[●]** to switch to stand-by.



Searching through a compact disc



You can search through a compact disc to find a specific point on the disc. Keep your finger on  to search forwards, or on  to search backwards through the tracks. Lift your finger to stop



searching. Playing starts immediately.

You can search at three speeds. If you keep your finger on  or , the speed will accelerate.

Stepping through tracks

Press  once to step forwards to the next track. Press  the number of times required to step to the desired track further ahead.

Press  once to step backwards to the beginning of the track you are listening to. Press  twice or more to step to preceding tracks.

If you want to play a track two or more steps ahead or behind, keep your finger on  or . The STEP> or <STEP cue flashes once for each step the CD-player will make.

Digital output

The digital output on the rear panel is intended for possible future digital equipment.



THE BEOGRAM 4500

This section explains how to operate the Beogram 4500. Before you start using the record player, make

sure you have set it up according to the instructions in the section "Setting up".

Adjusting stylus pressure

The stylus pressure must be adjusted to match the MMC cartridge fitted on the tonearm. Set the slider situated on the right-hand side of the tonearm to the appropriate value:

MMC 1 = 1.0 gram
 MMC 2 = 1.0 gram
 MMC 3 = 1.2 grams
 MMC 4 = 1.2 grams
 MMC 5 = 1.5 grams

If you want to check the stylus pressure using a stylus gauge, place the gauge underneath the stylus and lower the tonearm onto the gauge by pressing  for more than two seconds. The pressure can now be read off from the gauge.

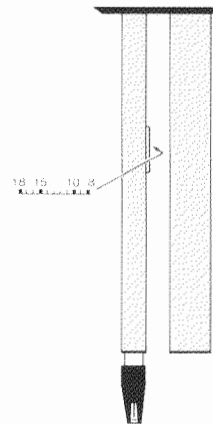

Setting speed

The Beogram 4500 automatically registers the size of the record on the turntable and selects the appropriate speed, 33 or 45 rpm. The speed selected appears on the

indicator arm. The speed can also be selected manually, if required. Press **PLAY** and then **33** or **45**, as the case may be.



Playing a record



If you want to clean the record before playing, press **←** to start turntable rotation. The tonearm moves into position without lowering onto the record.

Press **PLAY** to start playing.

If there is no record on the turntable when you press **PLAY**, the turntable rotates briefly, and the tonearm remains in its resting position.





Playing continues until the record is finished, or until you press **●** to switch the record player to standby.

Pausing

Press  or  to lift the tonearm off the record. The tonearm rises and remains in this position while the turntable continues rotating. Press  when you want to resume playing.



If the record player is left in pause for more than 8 minutes, it will automatically switch to stand-by.



Stepping through a record

You can move the tonearm to any position on a record and start playing from there. Use  to move the tonearm towards the centre of the record or use  to move the tonearm to the edge of the record. Keep your finger on  or  until you reach the desired spot. Then release the button and press  to start playing.

During this procedure a tiny beam of light illuminates the record to help you find the desired spot.

Repeating a record

You can make the record player play a record up to seven times in a row. Press  to start playing, then press  again the number of times you want to have the record repeated. The speed indicator flashes indicating that the record will be repeated.

If you press ,  or , the repeat command will be cancelled.

REMOTE CONTROL

The Beolink 1000 is a versatile remote control unit. It allows you to operate all the units in your Beosystem 4500 from a distance.

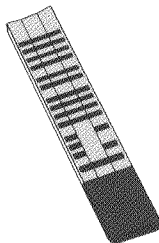

Primary functions

Play radio

Press **RADIO**.

Select preset stations

Press **0** - **9** or **>** **<**.

Automatic tuning

Press **GO TO** **>** or **<**.

Raise volume

Press **▲**.

Lower volume

Press **▼**.

Reset sound

Press **RESET**.

Mute the sound

Press **MUTE**.

Recall the sound

Press **MUTE** again.

Play tape

Press **A.TAPE**.

Stop playing

Press **STOP**.

Resume playing

Press **PLAY**.

Wind or rewind tape

Press **>>** or **<<**.

Select track number

Press **0** - **9** or **>** **<**.

Play compact disc Press **[CD]**.

Stop playing Press **[STOP]**.

Resume playing Press **[PLAY]**.

Search through compact disc Press **[>]** or **[<<]**.

Stop searching Press **[STOP]** or **[PLAY]**.

Select track number Press **[0] - [9]** or **[>] [<]**.

Play record Press **[PHONO]**.

Stop playing Press **[STOP]**.

Resume playing Press **[PLAY]**.

*Step through record
(in 8 mm increments)* Press **[>]** or **[<]**.

Switch off audio system Press **[●]**.

Switch off Beolink system Press **[SHIFT] [●]**.

THE BEOMASTER 4500 IN A BEOLINK SYSTEM

The Beolink system enables you to operate the audio system through the video master and to operate the video system through the audio master. This means that you can listen to the radio through the TV speakers or hear a TV program through the audio speakers.

The Beomaster 4500 is a Beolink master. You can connect it to a Beolink compatible TV-set and thus obtain the special Beolink functions. Connect the TV-set to the AUX/TV socket on the rear panel of the Beomaster 4500 using a 7-pin DIN cable (please see "Optional accessories").

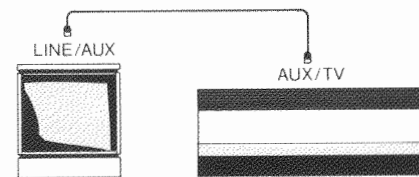

The Beolink system may be set up in two ways to suit individual patterns of use.

Situation 1:

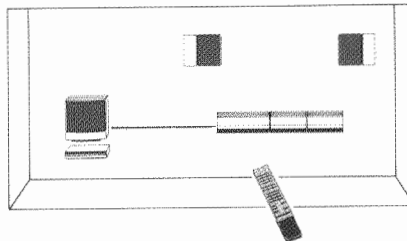

The audio and video systems are placed close to each other so that the commands from the Beolink 1000 can be received by both systems at a time.

Situation 2:

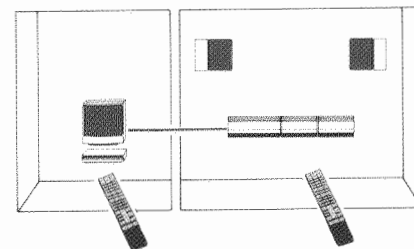

The audio and video systems are placed far apart, e.g. in separate rooms, so that the commands from the Beolink 1000 can be received only by one system at a time.

Pre-programming

Both the audio and video masters in a Beolink system must be pre-programmed according to the chosen set-up. You must use the Beolink 1000 to pre-program the Beomaster 4500, which must be in stand-by mode during pre-programming.

The Beomaster 4500 can also be pre-programmed for Master Control Link 2 system set-ups.

If you place an MCL 2 unit close to the Beomaster 4500 (Beolink system, situation 2), the Beomaster 4500 must be set to option 3.

If you place an MCL 2 unit in the same room as the audio and video systems (Beolink system, situation 1), the Beomaster 4500 must be set to option 4.

Situation 1 (option 1):

Press **[SOUND] 1 [STORE]**.

OP 1.5 (or OP 1.6) appears in the display confirming that the commands have been received.

Situation 2 (option 2):

Press **[SOUND] 2 [STORE]**.

OP 2.5 (or OP 2.6) appears in the display confirming that the commands have been received.

The digits 5 or 6 appearing in the display next to the chosen option number (1-4) are special options applying to the Master Control Link 2 system. Option 5 indicates that the Beomaster 4500 is a master in the MCL 2 system, and option 6 indicates that the Beomaster 4500 is a slave in the MCL 2 system. Option 6 is for future use and must not be selected.

*To select options 3 to 6, press **[SOUND]**, the appropriate number, then **[STORE]**.*

When the Beomaster 4500 leaves the factory, it is set to option 1.5.

How to obtain the Beolink functions

If your Beolink system is set up according to [situation 2](#), you can operate the audio or video system as usual to obtain the Beolink functions.

If, however, your Beolink system is set up according to [situation 1](#), you must use the **AV** button on the Beolink 1000 to obtain the Beolink functions. The **AV** button relays the commands following the **AV** command from one system to the other.

For example, if you press **AV** and then **CD**, the compact disc player will start playing, but the music will be reproduced by the TV speakers. If you press **AV** and then **TV** you will hear the TV program in the audio speakers.

OPTIONAL ACCESSORIES

The accessories referred to in this section are all available as optional extras from your Bang & Olufsen dealer.

WB 4500 wall bracket

The WB 4500 wall bracket, type no. 2030, is specially designed for the Beosystem 4500. It enables you to hang the Beomaster 4500, the Beocord 4500 and the Beogram CD 4500 on the wall. One wall bracket is required for each of these products.

Add the shelf, type no. 2012, for the Beogram 4500, and you will have the whole Beosystem 4500 hung on the wall.

Cable Cover 4500

The cable cover, type no. 6030, provides excellent concealment of leads and cables if the Beosystem 4500 is hung on a WB 4500 wall bracket. Its metal surface matches perfectly with the Beosystem 4500.

Length: 1.3 m.

Headphones

The Bang & Olufsen Form 1 or Form 2 stereo headphones can be connected to the Beomaster 4500 through the headphones socket on the front. If you plug in headphones, the loudspeakers connect-

ed to the upper pair of speaker sockets (1 L/R) are cut out.

Indoor antennae

If FM reception is good in your area, you may rely on the indoor FM antenna, part no. 8902010, to pick up the stations available. Attach it to the Beomaster 4500 using an antenna bracket, part no. 3152006.

The active AM antenna AA10, part no. 8920376, can be used for reception of distant AM stations. It is fitted with mains plug and indicator for connection to the mains.

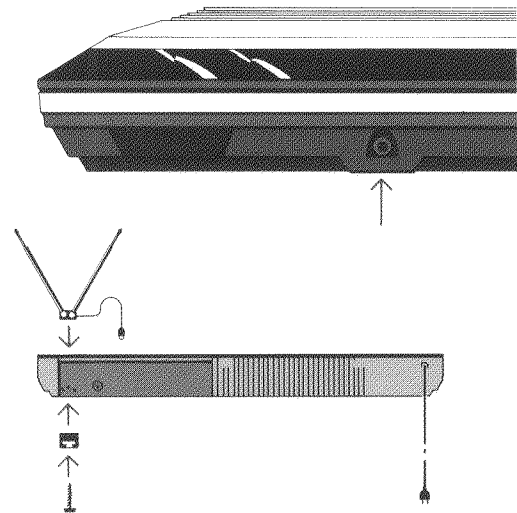

Beolink cable

A Beolink cable with 7-pin DIN plugs (Datalink) is required to connect your audio and video systems to form a Beolink system. The Beolink cable is available in different lengths:

Part no.
 6270222, black, 1.5 m
 6270353, black, 5 m
 6270337, black, 10 m
 6270354, black, 20 m
 6270338 (extension cable), 1.5 m

Part no.
 6270393, grey, 1.5 m
 6270394, grey, 5 m
 6270395, grey, 10 m
 6270396, grey, 20 m

Master Control Link 2

The MCL 2 system enables you to listen to music in any room in your house in which you have installed an MCL 2 A or 2 AV and a pair of loudspeakers or a TV-set. The MCL 2 system must be connected to the lower pair of speaker sockets (2 L/R) on the Beomaster 4500. You can operate all the functions in the Master Control Link 2 system using the Beolink 1000.

Ask your dealer for further details about the MCL 2 system.

Surfaces

Use a dry cloth to wipe dust off each unit of the Beosystem 4500. Fingerprints and grease stains can be removed with a firmly wrung soft cloth dipped in a solution of luke-warm water and a mild detergent.

Lime stains on the aluminium surfaces, caused by dried water drops, can be removed by a lime dissolving solution, e.g. 30% acetic acid.

Never use denatured alcohol to clean any parts of the Beosystem 4500.

Tape path

The tape path, i.e. tape heads, pinch rollers and other parts which the tape touches during play or recording, should be cleaned every now and then to prevent dust and fluff building up on them.

Use a tape head maintenance kit or a cotton swab dipped in a special fluid designed for this purpose. The cleaning process must be carried out with no cassette in the compartment.

Cleaning the tape head and pinch rollers is easier when they are in an exposed position. Press **[PLAY]** to expose the tape head and the left-hand pinch roller and clean them as prescribed. Press **[PLAY]** again to expose and clean the right-hand pinch roller. During this process the pinch rollers will be turning. Press **[STOP]** to finish the cleaning process.

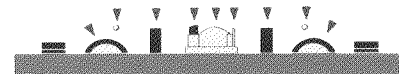

Stylus

Fluff and dust can build up on the tip of the stylus and cause distortion during play. Therefore, clean the stylus every now and then using the tiny brush provided.

Carefully brush the stylus from the back of the cartridge towards the front. Any stylus cleaning fluid should be used in moderate amounts.

Reducing the amount of dirt and dust on the record to a minimum is of course the best way to keep the stylus clean and thus to ensure optimum performance. For this purpose we recommend you use the Bang & Olufsen LP Protector record maintenance kit. The Bang & Olufsen LP Protector is available from your Bang & Olufsen dealer.

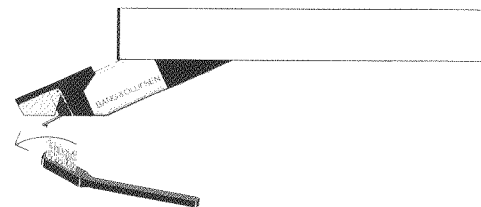

TECHNICAL SPECIFICATIONS

<i>Beomaster 4500</i>	<i>Type no. 2961/2962/2964/2965</i>
Long-term max. output power IEC	2 x 55 watts/8 ohms
Power output 20-20,000 Hz IHF	2 x 20 watts/8 ohms
Total harmonic distortion IHF	<0.1% at 20 watts 20-20,000 Hz
Dynamic headroom	1.6 dB/8 ohms
Intermodulation IHF	<0.1%
Response vs frequency:	
Phono - tape	20-20,000 Hz \pm 1.5 dB
Wideband damping factor	32
Input sensitivity/impedance:	
Tape1 - Phono/Tape2 - AUX - CD	30 mV/100 kohms
Signal-to-noise ratio:	
Phono A-weighted	>75 dB
Tape - CD A-weighted	>77 dB
Output:	
Tape	500 mV/470 ohms
Headphones	Max. 15 volts/220 ohms
FM range	87.5 - 108 MHz
FM aerial impedance	75 ohms
Usable sensitivity stereo	19 dBf-2.5 μ V/75 ohms
50 dB quieting sensitivity stereo	40 dBf-28 μ V/75 ohms
Signal-to-noise ratio 65 dBf stereo	70 dB
Frequency response	20-15,000 Hz \pm 1 dB
Distortion at 65 dBf stereo	0.3%
Intermodulation stereo	0.1%
Stereo channel separation	40 dB
AM tuner section:	
LW range	150-350 kHz
MW range	520-1610 kHz
LW sensitivity 20 dB S/N ratio	80 μ V
MW sensitivity 20 dB S/N ratio	60 μ V
Power supply	2961: 220 volts 2962/2965: 240 volts 2964: 100 volts
Power frequency	50-60 Hz
Power consumption	10-135 watts
Dimensions W x H x D	62 x 7 x 24.5 cm
Weight	7 kg

<i>Beocord 4500</i>	<i>Type no. 4961/4962/4964/4965</i>
Compact cassette	C46-C60-C90-C120
Recording system	HX PRO
Tape head	Sendust
Wow and flutter WRMS	<0.09%
Frequency range chrome	30-18,000 Hz \pm 3 dB
Signal-to-noise ratio CCIR/ARM:	
Metal Dolby B NR	>64 dB
Chrome Dolby B NR	>63 dB
Ferro Dolby B NR	>62 dB
Radio input, Line	100 mV/22 kohms
Radio output	660 mV/200 ohms
Power supply	4961: 220 volts
	4962/4965: 240 volts
	4964: 100 volts
Power frequency	50-60 Hz
Power consumption	18 watts
Dimensions W x H x D	42 x 7 x 24.5 cm
Weight	4.5 kg
<i>Beogram CD 4500</i>	<i>Type no. 5171/5172/5174/5175</i>
Frequency range	3-20,000 Hz \pm 0.3 dB
Signal-to-noise ratio	>100 dB/110 dB A-weighted
Harmonic distortion	<0.0025% at 0 dB
	<0.025% at -20 dB
Channel difference	<0.08 dB
Converter system	2 x 16 bit, 4 x oversampling 176.4 kHz
Low-pass filter	Digital + Bessel/elliptical analog
Phase error between L and R	0 degree at 20-20,000 Hz
Output, analog	1.3 volts RMS at 0 dB
Output, digital	For digital equipment
Power supply	5171: 220 volts
	5172/5175: 240 volts
	5174: 100 volts
Power frequency	50-60 Hz
Power consumption	23 watts
Dimensions W x H x D	42 x 7 x 24.5 cm
Weight	4.5 kg

<i>Beogram 4500</i>	<i>Type no. 5951/5954/5955</i>
Tonearm	Tangential Optimum Pivot Point
Motor	Servo controlled DC
Wow and flutter, WRMS	<0.03%
Rumble DIN weighted	>80 dB
Speeds	33-45 rpm.
Speed deviation	<±0.2%
Power supply	5951/5955: 190-265 volts 5954: 90-130 volts
Power frequency	50-60 Hz
Power consumption	<10 watts
Dimensions W x H x D	42 x 7.5 x 32.5 cm
Weight	5.3 kg
Pick-up preamplifier RIAA	Built-in, optimized for MMC
Frequency range	20-20,000 Hz ±1 dB
Signal-to-noise A-weighted	>80 dB
Distortion 1000 Hz	<0.02%
Output 1000 Hz, 20 cm/sec.	1 volt
Output impedance	<2 kohms
<i>Subject to change without notice</i>	

The Beocord 4500, the Beogram 4500 and the Beogram CD 4500 fulfil the conditions stated in the EEC Directive 82/499 concerning radio frequency interference.

INTERNATIONAL GUARANTEE

This Bang & Olufsen product carries a guarantee against defects in workmanship and materials. It is a national guarantee, extended by Bang & Olufsen to the country in which the product was bought. The terms of the guarantee apply principally to the country of purchase but will be met by authorized Bang & Olufsen dealers in other countries. The guarantee period applying to the country of purchase takes priority over guarantee periods applying in other countries, even where differences exist.

In order to obtain service under this guarantee, a certificate stating the following information is required:

- Name of product and type number
- Serial number
- Date of purchase
- Guarantee period
- Dealer's or supplier's signature

Bang & Olufsen
DK-7600 Struer
DENMARK

3502665

8059